



WIRELESS DIGITAL OTOSCOPE

DE550/551 User Manual



THANKS FOR SELECTING A FIREFLY OTOSCOPE

To take full advantage of this product's advanced capabilities, and to properly and safely use this product, please read the manual carefully.

Manufactured by FIREFLY GLOBAL – 464 COMMON ST, #281, BELMONT, MA 02478, USA

Copyright 2020 by Firefly Global. All rights are reserved. No one is permitted to reproduce or duplicate, in any form, this manual or any part thereof without permission from Firefly Global (www.fireflyglobal.com).

Firefly Global assumes no responsibility for any injury, or for any illegal or improper use of the product, that may result from failure to use this product in accordance with the instructions, cautions, warnings, or indications for use published in this manual.

Software in this product is copyright of Firefly Global and its vendors. All rights are reserved. The software is protected by U.S. and international copyright laws and international treaty provisions applicable worldwide. Under such laws, the licensee is entitled to use the copy of the software incorporated with this instrument as intended in the operation of the product in which it is embedded. The software may not be copied, decompiled, reverse-engineered, disassembled or otherwise reduced to human-perceivable form. This is not a sale of the software or any copy of the software; all rights, title, and ownership of the software remain with Firefly and/or its vendors.

Caution: Changes or modifications not expressly approved by Firefly Global will void the purchaser's authority to operate the equipment and its warranty.



MDSS GmbH
Schiffgraben 41
30175 Hannover, Germany



Tested To Comply
With FCC Standards
For Home or Office Use

Table of Contents

Introduction	4
Warnings & Cautions	5
Check List	7
Nomenclature	8
Operation	9
Setting up the Otoscope with Specula:	9
Connecting to PC and Powering the Device On:	10
Charging the Battery:	11
Channel Mapping:	11
Recommended Holding Position:	12
Brightness Adjustment:	12
Using the Image Capture Control:	12
Using Focus:.....	13
Maintenance and service	15
Service policy	16
Specifications	17
Limited Warranty	18
Troubleshooting	21

INTRODUCTION

The Firefly Wireless Digital Otoscope system consists of a wireless digital otoscope, a compact USB receiver, software application and a charge cable. Only a computer equipped with a free USB port is needed to use the system.

The Firefly Wireless Digital Otoscope system is designed for effective operation under a variety of conditions and typical video parameters are set at the factory. The software allows users to adjust most parameters including Saturation, Hue, Brightness, Contrast and Sharpness for desired applications.

System Requirements

The Firefly Otoscope System requires a user PC system running Windows 7 or later operating system, a viewing screen, and an available USB 1.1 or 2.0 port.

Intended use

The Firefly Wireless Digital Otoscope is intended to allow inspection of the external ear, ear canal, and the tympanic membrane under magnification.

User Profile

The Firefly Wireless Digital Otoscope is intended for applications such as:

- Medical examinations
- Veterinary examinations
- Science Education
- Telemedicine

Warranty Registration

Register your Firefly device at <http://www.fireflyglobal.com/warranty-registration/> within two weeks of your purchase and maintain your original receipt.

Product Support

Please visit the FAQ section of our website at <http://www.fireflyglobal.com> for the latest troubleshooting information and additional support. You can also contact us at support@fireflyglobal.com Monday through Friday 9:30 AM to 5:30 PM Eastern Time.

WARNINGS & CAUTIONS

Please familiarize all operating personnel with the general safety information in this summary. Specific warnings and cautions are also found throughout this manual.

Warning



A warning statement in this manual identifies a condition or practice which if not corrected or discontinued immediately, could lead to injury, illness, or death.

- Do not use in the presence of flammable anesthetics.
- This product has no user serviceable/replaceable parts. Please refer all service to authorized service personnel.
- This instrument is not intended to be used in the eye.

Caution



A caution statement in this manual identifies condition or practice, which if not corrected or discontinued immediately, could lead to equipment failure, equipment damage, or data loss.

- In order to obtain optimum performance and ensure patient safety, thoroughly read this manual.
- Do not use the Firefly Otoscope if you notice any signs of damage to the components of the system. Contact customer service for immediate assistance.
- Do not attempt to disinfect the Firefly Otoscope System using glutaraldehyde products, ethylene oxide gas, steam or any other liquid or gas disinfectant.
- The signal output (USB Port) connector is intended for connection of only devices complying with IEC 60601-1, or other IEC standards (for example, IEC 60950), as appropriate to the device. Connecting additional devices to the Firefly Otoscope System is not allowed.

- This product complies with current required standards for electromagnetic interference and should not present problems to other equipment or be affected by other devices. As a precaution, avoid using this device in close proximity to other equipment.

- Do not apply alcohol, chemicals, or water to the lens. Any liquids entering the optical assembly will damage internal components.

CHECK LIST

Before starting, check that all the following items have been included with your product. If anything is missing, contact your dealer.

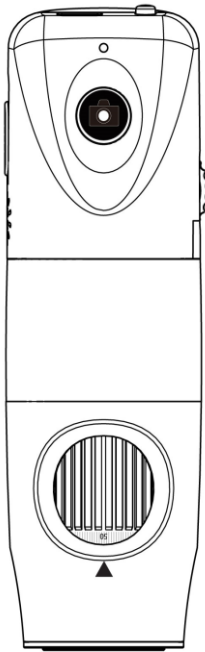

Otoscope x 1pc

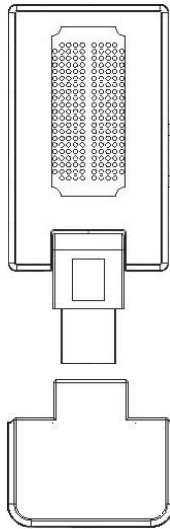

Receiver x 1 pc

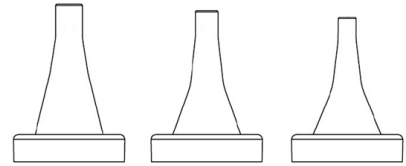

5mm 4mm 3mm

DE550 Human one-time use specula (multiple pieces)

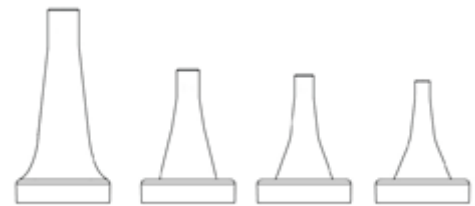

7mm 5mm 4mm 3mm

DE551 Veterinary one-time use specula (multiple pieces)



Power Adapter x 1pc
100-240V AC to 5V USB DC
Notice: Actual Shape may vary.



USB Charger Cable x 1 pc

NOMENCLATURE

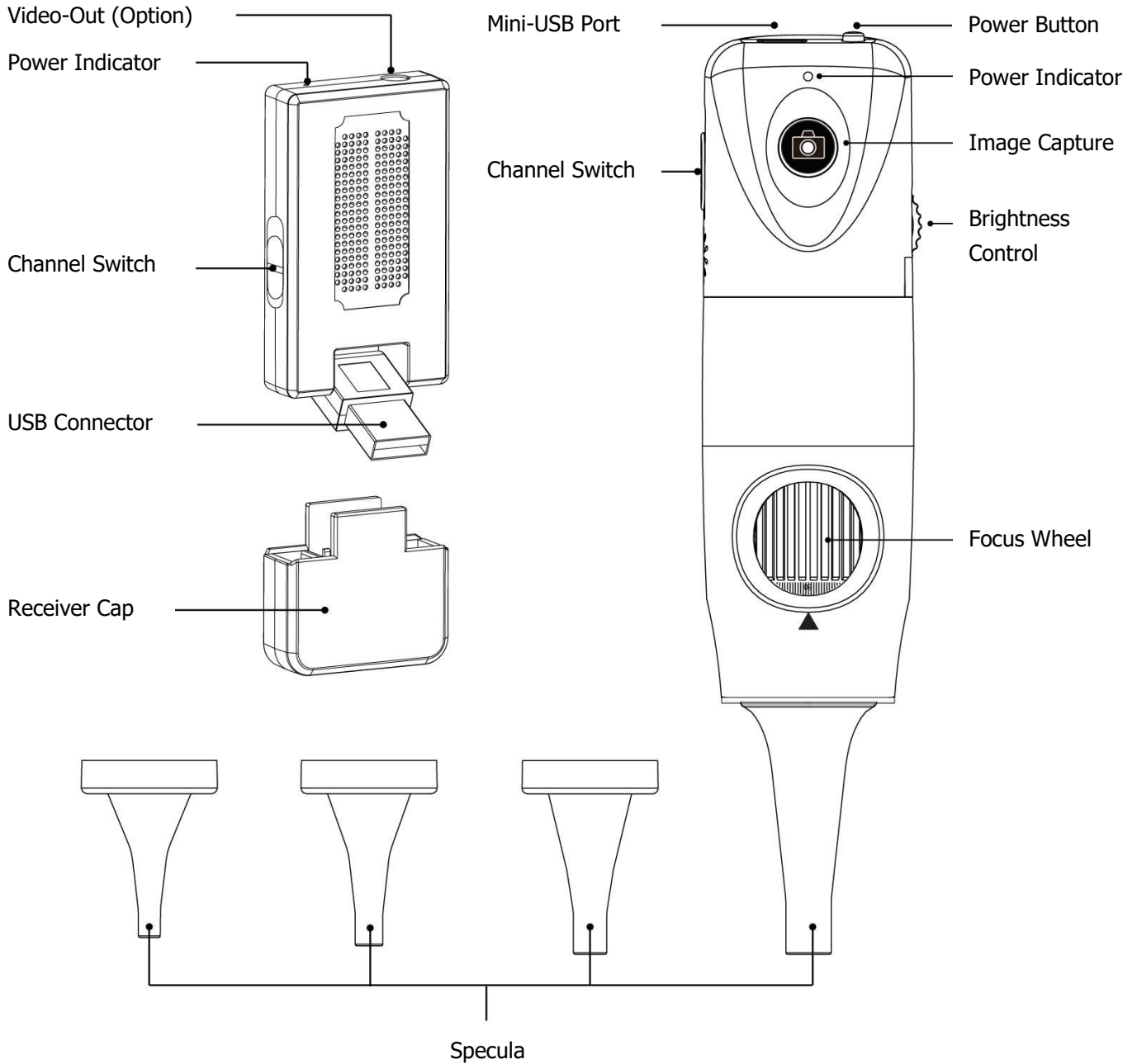

OPERATION

Setting up the otoscope with specula:



Only accepts original specula qualified for use with Firefly otoscopes.

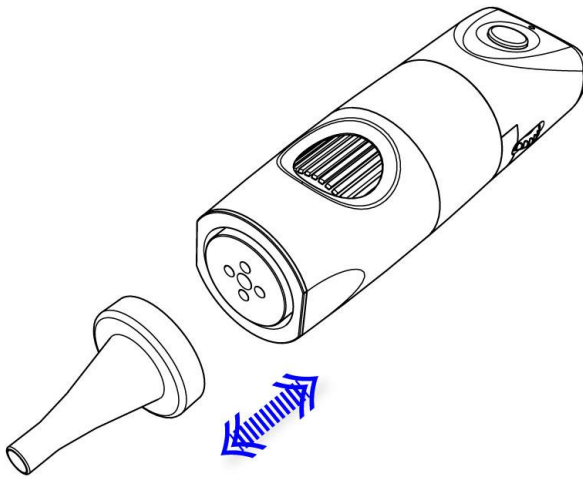

Plug the specula into the round concave guide in front. To remove: Simply pull to unplug the specula.

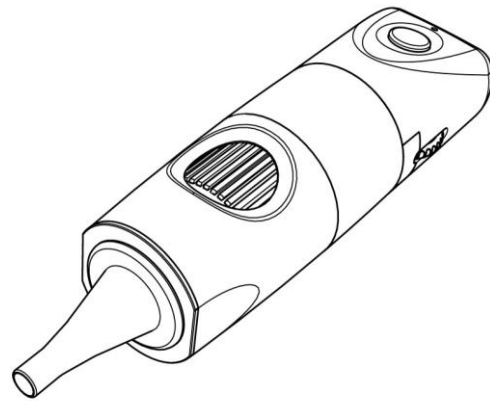

Ensure a tight fit for proper operation and adjust specula such that the circular opening is centered on the screen.

Setting up the Software Application:

Prior to using the Firefly Otoscope for the first time, download the FireflyPro software from the Firefly website at the following link: www.fireflyglobal.com/downloads

Install the FireflyPro software, following the instructions on the website. Versions are available for both Windows and Mac platforms. The software is self-explanatory and easy to use.

Connect to PC:

Connect the compact receiver to the PC's USB port.

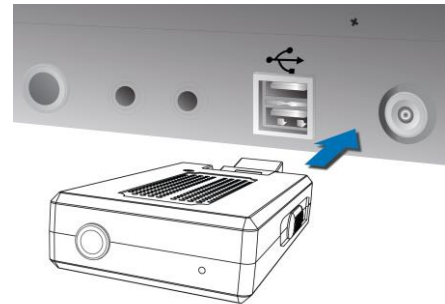
**Power the Device On:**

Push the 'Power Button' at the rear of the otoscope to activate the device. An indicator light will turn on to confirm the power status.

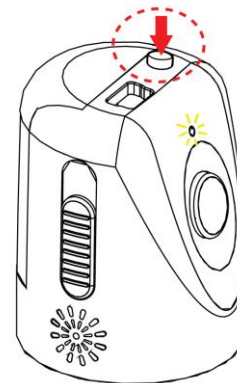
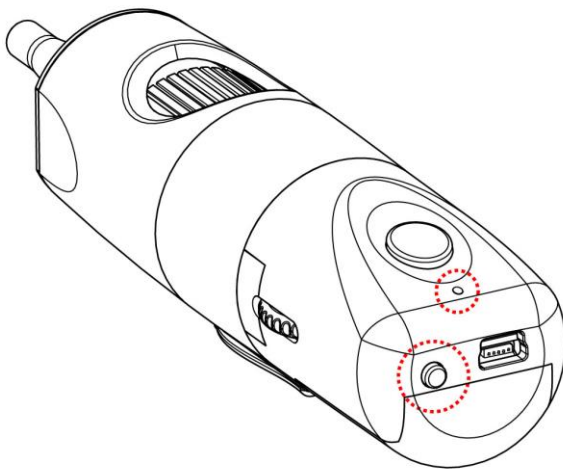

Charging the Battery:

■ Duration:

The Wireless Firefly Oscope has a built-in high efficiency lithium battery that enables more than 2.5 hours continuous operation.

■ Charging the Battery:

Through the mini-USB port at the rear of the oscilloscope, the embedded battery can be charged with the provided USB DC cable. The cable must be connected to the USB port of a PC or to the "USB Power Adapter", which can charge directly from a wall outlet.

■ Overload Protection:

The overload protection circuit will prevent overcharging when the battery is full and the "Indicator" will turn green.

■ Power Indication:

The power indicator light is normally red during operation, but it will turn blue when the remaining battery life is less than 30 minutes.



The lithium battery is a delicate and consumable item. It is expected to last through years of use and is guaranteed for twelve months from its purchase against defects. If there is any battery related issue, please contact customer service immediately. Battery replacement by unauthorized personnel or replacement with unauthorized batteries may damage the system and voids the overall warranty.

Channel Mapping:

On the rear right side of the oscilloscope, there is a switch allowing users to set the wireless channel. Both the receiver and oscilloscope must be set to the same channel for proper operation:

- ◆ CH 1: Channel 1
- ◆ CH 2: Channel 2
- ◆ CH 3: Channel 3
- ◆ CH 4: Channel 4

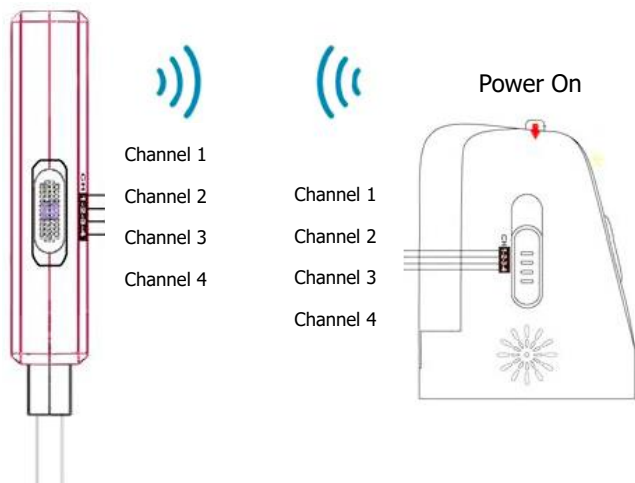

Recommended holding position:

It is suggested to hold the otoscope, transparent cover forward, with the thumb held on the equipment. This holding position offers relative stability and allows lens control. The index finger is still free to rotate and adjust the focus wheel (as shown).



Brightness Adjustment:

On left rear side of the otoscope, a knob allows the user to control the brightness of the LEDs:

- ◆ Backward Turn: Decrease Brightness
- ◆ Forward Turn: Increase Brightness

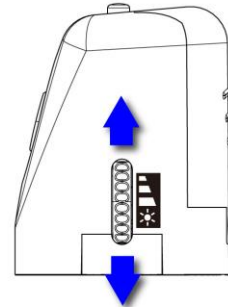

Using the Image Capture Control:

Press and release the Capture button to capture image frames. The system will generate a shutter sound from the PC speaker as confirmation.

Image
Capture

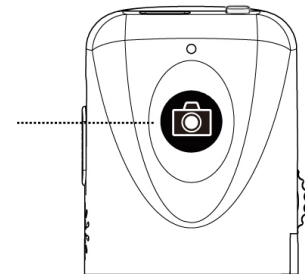

Using Focus:

Based on the relative distance of the observed object, the focus wheel can be turned for a clear image. When a higher magnification is required, the focus wheel can be turned to the left (see below). If a larger field of view is required, the otoscope can be moved farther away and the wheel turned to the right.

Free focus:
Rotate wheel to fine
tune the image

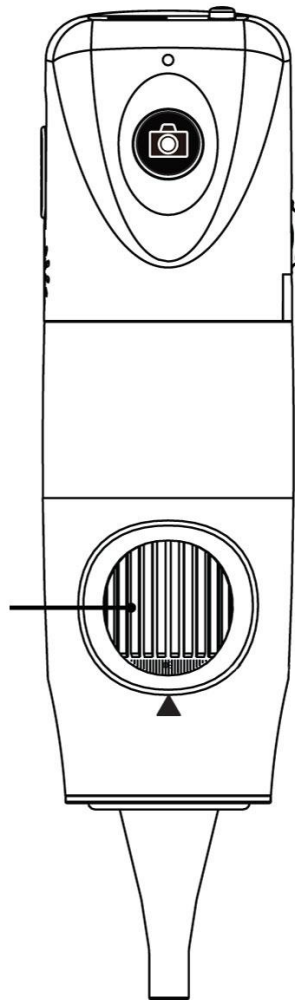

Standby and Remove device:

To temporarily turn off or remove the device, push and release the power button to the "OFF" position.

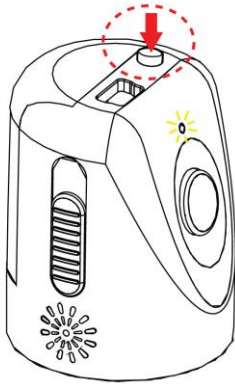

Next, exit the FireflyPro software application. You can then remove the USB receiver from the PC.

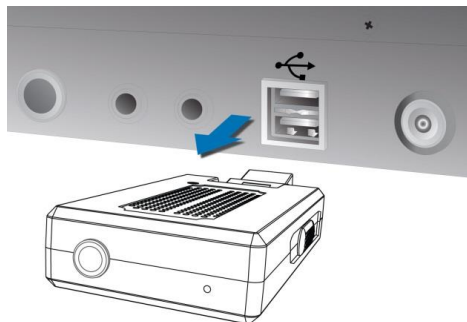

MAINTENANCE AND SERVICE

Cleaning recommendation



CAUTION Do not apply alcohol, chemicals, or water to the lens. Any liquids entering the optical assembly will damage internal components.

Use a dry cloth to clean the Firefly Wireless Digital Otoscope on a weekly basis.

Recycling the system components

Within the EU



Do not dispose of this product as unsorted municipal refuse. Submit for separate collection as specified by Directive 2002/96/EC of the European Parliament and the Council of the European Union on Waste Electronic and Electrical Equipment (WEEE).

If this product is contaminated, this directive does not apply. For more specific disposal information contact Customer Service.



Outside the EU

When the product and its components reach end of life, recycle the product according to national, state, and local regulations.

SERVICE POLICY

All repairs on products under warranty must be performed or approved by Firefly or its authorized resellers. Unauthorized repairs will void the warranty. In addition, whether or not covered under warranty, any product repair shall exclusively be performed by Firefly-certified service personnel.

If the product fails to function properly — or if you need assistance, service, or spare parts — contact your Firefly reseller.

Before contacting your reseller, try to duplicate the problem and check all accessories to ensure that they are not causing the problem. When calling, please be prepared to provide:

- Product name and model number and complete description of the problem.
- Serial number of your product (if applicable).
- Complete name, address and phone number of your facility.
- For out-of-warranty repairs or spare parts orders, a purchase order (or credit card) number.
- For parts orders, the required spare or replacement part numbers.

If your product requires warranty, extended warranty, or non-warranty repair service, please contact your Firefly reseller. A customer service representative will assist you in troubleshooting the problem and will make every effort to solve it over the phone, avoiding potential unnecessary returns. In case a return cannot be avoided, the representative will record all necessary information and will provide a Return Authorization number, as well as the appropriate shipping address. The Return Authorization number must be obtained prior to any return.

If you have to return your product for service, follow these recommended packing instructions:

- Disconnect all hoses, cables, sensors, power cords, and ancillary products (as appropriate) before packing, unless you suspect they are associated with the problem.
- Wherever possible use the original shipping carton and packing materials.
- Include a packing list and the Return Authorization number.

It is recommended that all returned goods be insured. Claims for loss or damage to the product are the responsibility of the sender.

SPECIFICATIONS

Item	Specification
Weight	Approximately 100 g (0.22 lb)
Dimensions (approximate)	Length: 11.4 cm (4.5 inches) Height: 3.7 cm (1.5 inches) Width: 3.7 cm (1.5 inches)
Ratio	USB 5 VDC, 150mA
Protection against ingress of water	IPXØ
Operating conditions	
Temperature	+10°C to +40° C (+50°F to +104°F)
Relative humidity	30% to 75% noncondensing
Altitude	700 to 1060 hPa
Shipping & storage conditions	
Temperature	-20°C to +49°C (-4°F to +120°F)
Relative humidity	95% noncondensing max.
Wireless power	Less than 10mW
Sensitivity	-87dBm
Noise ratio	47dBm
Antennae resistance	50Ω
Available Channels	4
Coverage	Over 5 meters (15ft) on open field
Battery	More than 2.5 hours continuous usage
Capacity	850mAh (Lithium battery)
Service	Authorized personnel only
Safety Compliance	FCC, CE and RoHS compliant

LIMITED WARRANTY

Limited Hardware Warranty (through distributors & resellers)

Firefly Global hardware products come with a 1-year limited hardware warranty. The warranty is extended through Firefly Global authorized representatives and resellers. If you have a warranty claim, please contact the store, distributor, or website through which the product was purchased.

Register your Firefly device at <http://www.fireflyglobal.com/warranty-registration/> within two weeks of your purchase and maintain your original receipt.

What is covered by this limited hardware warranty?

This limited hardware warranty covers defects in materials and workmanship in your Firefly Global hardware products.

What is not covered by this limited hardware warranty?

This limited hardware warranty does not cover:

- Software, including the operating system and software added to or bundled with the Firefly Global hardware products
- Problems that result from:
 - External causes such as accident, abuse, misuse, or problems with electrical power
 - Servicing not authorized by Firefly Global
 - Usage that is not in accordance with product instructions
 - Failure to follow the product instructions
 - Problems caused by using accessories, parts, or components not supplied by Firefly Global
- Products with missing or altered serial numbers
- Products for which Firefly Global or its distributors have not received payment
- Normal wear and tear

THIS WARRANTY GIVES YOU SPECIFIC LEGAL RIGHTS, AND YOU MAY ALSO HAVE OTHER RIGHTS WHICH VARY FROM STATE TO STATE (OR JURISDICTION TO JURISDICTION). FIREFLY GLOBAL'S RESPONSIBILITY FOR MALFUNCTIONS AND DEFECTS IN HARDWARE IS LIMITED TO REPAIR AND REPLACEMENT AS SET FORTH IN THIS WARRANTY STATEMENT. ALL EXPRESS AND IMPLIED WARRANTIES FOR THE PRODUCT, INCLUDING BUT NOT LIMITED TO ANY IMPLIED WARRANTIES AND

CONDITIONS OF MERCHANTABILITY AND FITNESS FOR A PARTICULAR PURPOSE, ARE LIMITED IN TIME TO THE TERM OF THE LIMITED WARRANTY PERIOD REFLECTED ON YOUR PACKING SLIP OR INVOICE. NO WARRANTIES, WHETHER EXPRESS OR IMPLIED, WILL APPLY AFTER THE LIMITED WARRANTY PERIOD HAS EXPIRED. SOME STATES DO NOT ALLOW LIMITATIONS ON HOW LONG AN IMPLIED WARRANTY LASTS, SO THIS LIMITATION MAY NOT APPLY TO YOU.

WE DO NOT ACCEPT LIABILITY BEYOND THE REMEDIES PROVIDED FOR IN THIS LIMITED HARDWARE WARRANTY OR FOR CONSEQUENTIAL OR INCIDENTAL DAMAGES, INCLUDING, WITHOUT LIMITATION, ANY LIABILITY FOR THIRD-PARTY CLAIMS AGAINST YOU FOR DAMAGES, FOR PRODUCTS NOT BEING AVAILABLE FOR USE, OR FOR LOST DATA OR LOST SOFTWARE. OUR LIABILITY WILL BE NO MORE THAN THE AMOUNT YOU PAID FOR THE PRODUCT THAT IS THE SUBJECT OF A CLAIM. THIS IS THE MAXIMUM AMOUNT FOR WHICH WE ARE RESPONSIBLE.

How long does this limited hardware warranty last?

The limited hardware warranty on all Firefly Global products begins on the date of the packing slip, invoice, or receipt. The warranty period is not extended if a warranted product or any parts are repaired or replaced. Firefly Global may change the availability of limited hardware warranties, at its discretion, but any changes will not be retroactive.

What do I do if I need warranty service?

Before the warranty expires, please contact the store, distributor, or website through which the product was purchased.

What will Firefly Global do?

Firefly Global or its authorized representative or reseller will repair any Firefly Global hardware products returned that prove to be defective in materials or workmanship. If Firefly Global or its authorized representatives are not able to repair the product, we will replace it with a comparable product that is new or refurbished.

When you contact our authorized representatives or resellers via phone or email, they will issue a Return Material Authorization Number for you to include with your return. You must return the products in their original or equivalent packaging, prepay shipping charges, and insure the shipment or accept the risk if the product is lost or damaged in shipment. The repaired or replacement products will be returned to you. The reseller or authorized representative will pay to ship the repaired or replaced products to you if you use a delivery address in the country where the reseller is located. Otherwise, the product will be shipped to you freight collect.

If it is determined that the problem is not covered under this warranty, you will be notified and informed of service alternatives that are available to you on a fee basis.

How will you fix my product?

We use new and refurbished parts made by various manufacturers in performing warranty repairs and in building replacement parts and systems. Refurbished parts and systems are parts or systems that have been returned to Firefly Global, some of which were never used by a customer. All parts and systems are inspected and tested for quality. Replacement parts and systems are covered for the remaining period of the limited hardware warranty for the product you bought. Firefly Global owns all parts removed from repaired products.

May I transfer the limited hardware warranty?

Limited hardware warranties are not transferable.

TROUBLESHOOTING

Please visit the FAQ section of our website at <http://www.fireflyglobal.com> for the latest troubleshooting information and additional support.

You can also contact us at support@fireflyglobal.com Monday through Friday 9:30 AM to 5:30 PM Eastern Time.

Thank you for choosing Firefly.



www.fireflyglobal.com